



Ergonesia

MADISON
ERGONOMIC
CHAIR

ENMD-K2-BM-0201 (KP03)

+

Experience ergonomics

NEW
PRODUCT



ENMD-K2-BM-0201 (KP03) Office Chair



Seat height adjustment



Backrest can be tilted 4 lock



Tilting Tension Adjustment



Sliding Seat



Lumbar support height adjustment



Neck-rest height adjustment



Armrest height adjustment



Armrest Pad Rotation



Armrest pad move forward & backward

TYPE
LY-01

Water-proof fabric for seat



SVHC

According to the specified scope and evaluation screening, the test results of SVHC are <math><0.1\%</math>(w/w) - PASS



Smolder Retardant

Fire retardant, it pass the fire retardant standard of CA TB117-2013



Water Repellency

Grade 6



Oil Repellency

Grade 6



Abrasion Resistance

Endpoint-Lengthwise is >100,000 cycles
Endpoint-Widthwise is >100,000 cycles



RUB Fastness

Dry Staining: Grade 4
Wet staining: Grade 4

TYPE GT-01

GT series of high elastic mesh

Ergonomics, can maintain the mesh pattern without being deformed



SVHC

According to the specified scope and evaluation screening, the test results of SVHC are <math><0.1\%</math>(w/w) - PASS



Formaldehyde content

NOT Detectable



Abrasion Resistance

Endpoint-Lengthwise is >100,000 cycles
Endpoint-Widthwise is >100,000 cycles



Smolder Retardant

Fire retardant, it pass the fire retardant standard of CA TB117-2013



RUB Fastness

Dry Staining: 4 grade
Wet staining: 4 grade



Tear Strength

Length is 116N
Transverse avulsion is 176N

3D ARMS ARMS IN BLACK



Control armrest up and down adjustment

- Height adjustable arms, with soft touch PU cap.
- The arm cap can be rotated, and it can be adjusted forward and backward.
- No sudden and major change in the structural integrity when 68 kg applied for 1 min.



BACKREST TILTING DEGREE

It is able to offer good sitting feelings to users. It would reduce stress to abdomen.

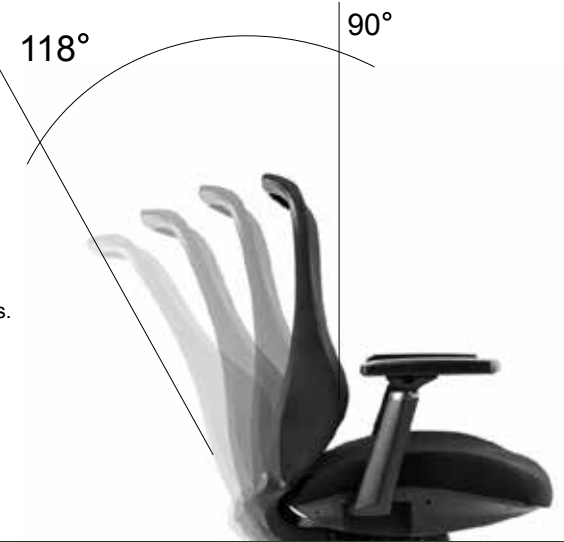

LUMBAR SUPPORT HEIGHT ADJUSTABLE

It's offering comfort to user.



SLIDING SEAT



Adjust the seat depth according to the user's angle and habit

**SHS CLASS 4 GAS LIFT
(TOP CLASS IN THE WORLD)**

International authority testing and certification



SHS CLASS 4

1. Class 4 gas lift from Korean Samhongs company
2. The wall thickness is 2.5 mm
3. With QPQ treated surface, this make gas lift is more strong than class 2 and class 3 gas lift.
4. Nitrogen purity is 99.7%, trust-worthy quality.



350 Aluminum BASE

FINISHING: POLISH

BIFMA standard test, high-strength load-bearing

350 mm Size
1136 kg Load capacity



*The pictures only show creative ideas, the specific data shall prevail



60 mm PU CASTORS

With the BIFMA test of 100,000 cycles when load 113 kg.

1000000 TIMES TEST



There is no loss for the structure when load 150 kg after 1,000 cycles with obstacle.

Silent castors

MOLDED FOAM FOR SEAT

Molded foam seat, it's durable and comfortable, it won't out of shape for 5 years.



14mm~15mm
The thickness of plywood board is 14 mm~15mm, this thick of plywood can make the chair more durable.

* Pass the fire retardant standard of CA TB117-2013

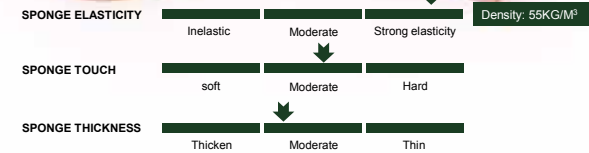



The unique frame of the chair ensures contact is maintained with your lower back in a normal curvature to help your back stay strong and healthy, and the adjustable lumbar support to ensure that the fit is right for users of all heights and shapes.

+

Experience ergonomics

NEW
PRODUCT



MADISON ERGONOMIC CHAIR

ENMD-K2-BM-0201 (KP03)



Ergonesia

MADISON ERGONOMIC CHAIR

ENMD-K2-K2-BH-0701
(KP01/02)

+
Experience ergonomics

NEW
PRODUCT



ENMD-K2-K2-BH-0701 (KP01/02) Office Chair



Seat height adjustment



Backrest can be tilted 4 lock



Tilting Tension Adjustment



Sliding Seat



Lumbar support height adjustment



Neck-rest height adjustment



Armrest height adjustment



Armrest Pad Rotation



Armrest pad move forward & backward

TYPE GT-01

GT series of high elastic mesh

Ergonomics, can maintain the mesh pattern without being deformed



SVHC

According to the specified scope and evaluation screening, the test results of SVHC are <math><0.1\%(w/w)</math> - PASS



Formaldehyde content

NOT Detectable



Abrasion Resistance

Endpoint-Lengthwise is >100,000 cycles
Endpoint-Widthwise is >100,000 cycles



Smolder Retardant

Fire retardant , it pass the fire retardant standard of CA TB117-2013.



RUB Fastness

Dry Staining: 4 grade
Wet staining: 4 grade



Tear Strength

Length is 116N
Transverse avulsion is 176N

TYPE

LY-01

Water-proof fabric for seat



SVHC

According to the specified scope and evaluation screening, the test results of SVHC are <math><0.1\%(w/w)</math> - PASS



Smolder Retardant

Fire retardant , it pass the fire retardant standard of CA TB117-2013



Water Repellency

Grade 6



Oil Repellency

Grade 6



Abrasion Resistance

Endpoint-Lengthwise is >100,000 cycles
Endpoint-Widthwise is >100,000 cycles



RUB Fastness

Dry Staining: Grade 4
Wet staining: Grade 4

3D ARMS ARMS IN BLACK



Control armrest up and down adjustment

- Height adjustable arms, with soft touch PU cap.
- The arm cap can be rotated, and it can be adjusted forward and backward.
- No sudden and major change in the structural integrity when 68 kg applied for 1 min.

Armrest pad rotation



Arms height adjustment



Armrest pad can slide back and forth



BACKREST TILTING DEGREE

It is able to offer good sitting feelings to users. It would reduce stress to abdomen.

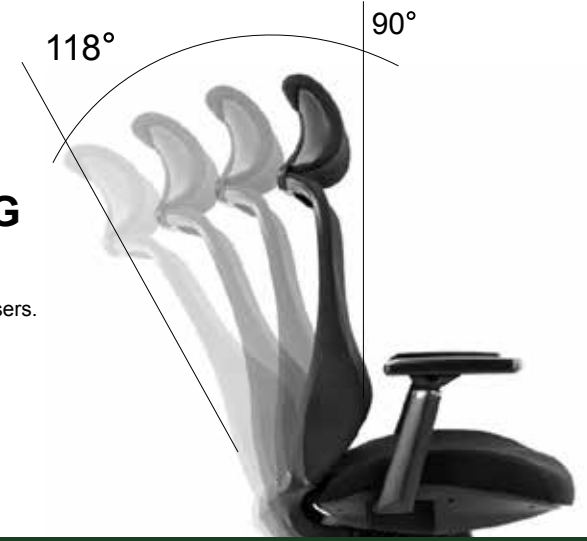

LUMBAR SUPPORT HEIGHT ADJUSTABLE

It's offering comfort to user.

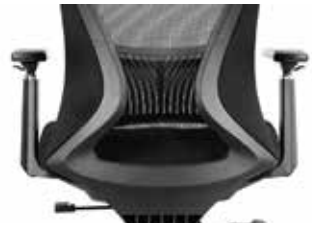

HEIGHT ADJUSTABLE HEADREST



Neck-rest height adjustment





SLIDING SEAT



Adjust the seat depth according to the user's angle and habit

SHS CLASS 4 GAS LIFT (TOP CLASS IN THE WORLD)

International authority testing and certification



1. Class 4 gas lift from Korean Samhongs company
2. The wall thickness is 2.5 mm
3. With QPQ treated surface, this make gas lift is more strong than class 2 and class 3 gas lift.
4. Nitrogen purity is 99.7%, trust-worthy quality.

350 Aluminum BASE

FINISHING: POLISH

BIFMA standard test, high-strength load-bearing

350 mm Size
1136 kg Load capacity



*The pictures only show creative ideas, the specific data shall prevail



60 mm PU CASTORS

With the BIFMA test of 100,000 cycles when load 113 kg.

1000000 TIMES TEST



There is no loss for the structure when load 150 kg after 1,000 cycles with obstacle.

Silent castors

MOLDED FOAM FOR SEAT

Molded foam seat, it's durable and comfortable, it won't out of shape for 5 years.



14mm~15mm

The thickness of plywood board is 14 mm~15mm, this thick of plywood can make the chair more durable.

* Pass the fire retardant standard of CA TB117-2013

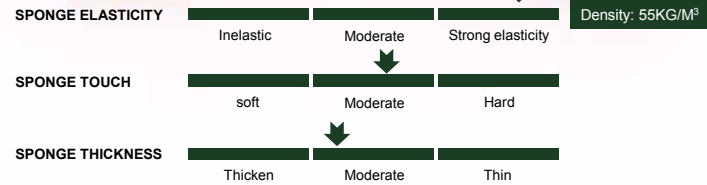

The unique frame of the chair ensures contact is maintained with your lower back in a normal curvature to help your back stay strong and healthy, and the adjustable lumbar support to ensure that the fit is right for users of all heights and shapes.

+

Experience ergonomics

NEW
PRODUCT



**MADISON
ERGONOMIC
CHAIR**

**ENMD-K2-K2-BH-0701
(KP01/02)**



Ergonesia

ERGONOMIC OFFICE CHAIR GK3-BM-01

+ Experience ergonomics

NEW PRODUCT



OUTSTANDING FEATURES

- Height adjustable lumbar
- PP armrest
- Single lock mechanism
- Class 4 gas lift
- 340# nylon base
- 60# castor



Backrest can be locked



Seat height adjustment



Lumbar support height adjustment



Tilting tension adjustment



Chair swivel

TYPE GT-04

GT series of high elastic mesh

Ergonomics, can maintain the mesh pattern without being deformed



SVHC

According to the specified scope and evaluation screening, the test results of SVHC are <0.1%(w/w) - PASS



Formaldehyde content
NOT Detectable



Abrasion Resistance

Endpoint -Lengthwise is >100,000 cycles
Endpoint - Widthwise is >100,000 cycles



Smolder Retardant

Fire retardant, it pass the fire retardant standard of CA TB117-2013



RUB Fastness

Dry Staining: 4 grade
Wet staining: 4 grade



Tear Strength

Length is 116N
Transverse avulsion is 176N

TYPE

LY-04

Water-proof fabric for seat



SVHC

According to the specified scope and evaluation screening, the test results of SVHC are <0.1%(w/w) - PASS



Smolder Retardant

Fire retardant, it pass the fire retardant standard of CA TB117-2013



Water Repellency

Grade 6



Oil Repellency

Grade 6



Abrasion Resistance

Endpoint -Lengthwise is >100,000 cycles
Endpoint -Widthwise is >100,000 cycles



RUB Fastness

Dry Staining: Grade 4
Wet staining: Grade 4



FIXED PP ARMS ARMS IN BLACK COLOR

No sudden and major change in the structural integrity when 68 kg applied for 1 min.

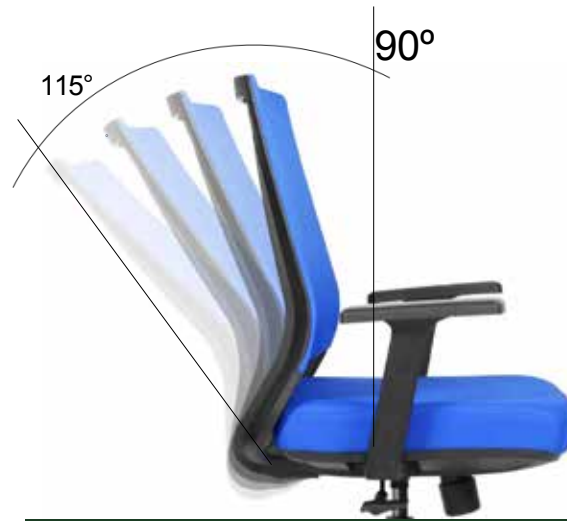

BACKREST TILTING DEGREE

It is able to offer good sitting feelings to users. It would reduce stress to abdomen.

LUMBAR SUPPORT HEIGHT ADJUSTABLE



It's made of nylon .



SHS CLASS 4 GAS LIFT (TOP CLASS IN THE WORLD)

International authority testing and certification



SGS

SGS CLASS 4

1. Class 4 gas lift from Korean Samhongs company
2. The wall thickness is 2.5 mm
3. With QPQ treated surface, this make gas lift is more strong than class 2 and class 3 gas lift.
4. Nitrogen purity is 99.7%. trust-worthy quality.

340 NYLON BASE IN BLACK

BIFMA standard test, high - strengthload - bearing

340 mm
Size

1136 kg
Load capacity



*The pictures only show creative ideas, the specific data shall prevail

MOLDED FOAM FOR SEAT

Molded foam seat, it's durable and comfortable, it won't out of shape for 5 years.



13mm~15mm

The thickness of plywood board is 14 mm-15 mm, this thick of plywood can make the chair more durable.

*Pass the fire retardant standard of CA TB117-2013



SPONGE ELASTICITY	Inelastic	Moderate	Strong elasticity	Density: 55KG/M ³
SPONGE TOUCH	soft	Moderate	Hard	
SPONGE THICKNESS	Thicken	Moderate	Thin	



60 MM NYLON CASTORS

With the BIFMA test of 100,000 cycles when load 1136g.

1000000 TIMES TEST



There is no loss for the structure when load 150 kg after 1,000 cycle with obstacle.

Silent castors



The unique frame of the chair ensures contact is maintained with your lower back in a normal curvature to help your back stay strong and healthy, and the adjustable lumbar support to ensure that the fit is right for users of all heights and shapes.

+ Experience ergonomics



**GK3-BM-01
OFFICE CHAIR**



Ergonesia

ERGONOMIC
MESH CHAIR
D-T8F-GHL-03

+
Experience ergonomics



Armrest height adjustment
The height of the armrest can be adjusted up and down according to the user's habits

The armrest pad slides back and forth
The armrest cap can slide back and forth according to the user's habits

The armrest pad rotation
The armrest pad can rotate right to left according to the user's habits

02 **Multi-functional armrest**



01 **Adjustable headrest**

It can be adjusted according to the height and neck position of the user, which is comfortable and convient



Headrest angle adjustment



Headrest height adjustment



03 **Integral back lifting adjustment**

Through the overall lifting adjustment of the back to adapt to the corresponding height and improve the user's comfort



Split double waist design
spring lumbar support



04 Tilttable and lockable backrest

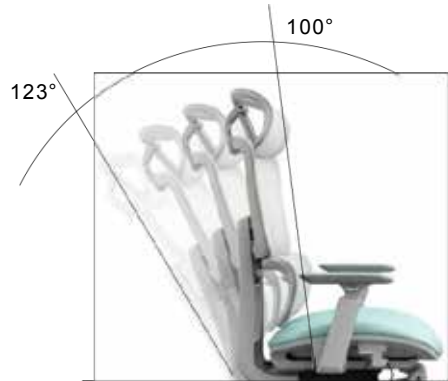

The backrest can be tilt and locked in 4 position, It is able to offer good sitting feelings to users. It would reduce stress to abdomen.



Fast Tension adjustment, It's only about 3 cycles from looses to tightest.



06 With folding footrest under the seat



Easily pull out and store to save space. Provide a higher quality resting environment for a nap.



The footrest surface is made of soft black PU leather, making your ankle more comfortable.



05 Seat Depth



Seat can be adjusted for depth, it's about 5 cm. Sliding seat can meet different users demand.



SHS CLASS 4 GAS LIFT (TOP CLASS IN THE WORLD)

International authority testing and certification



1. Class 4 gas lift from korean Samhongs company
2. The wall thickness is 2.5 mm
3. With QPQ treated surface, this make gas lift is more stron than class 2 and class 3 gas lift.
4. Nitrogen purity is 99.7%, trust - worthy quality.

TRACK NON-SLIP BASE IN GREY

BIFMA standard test , high - strength load-bearing

350 mm
Size

1136 kg
Load capacity



*The pictures only show creative ideas, the specific data shall prevail



60 MM NYLON CASTORS

With the BIFMA test of 100,000 cycles when load 113 kg.

100000

TIMES TEST



#There is no loss for the structure when load 150 kg after 1,000 cycles with obstacle.

Silent castors

07

Normal configuration (Support customization)



Concise , comfortable and elegant .fit to the human body , size and shape , design , attention is put to complete relaxation .

ERGONOMIC MESH CHAIR
D-T8F-GHL-03



- BIFMA Standard Ergonomic Black Office Chair
- Headrest: Large size headrest design, height adjustable, suitable for people of different heights, to achieve the most effective support and make the neck healthier.
- Backrest: The backrest can be adjusted up and down, which can be used by users of different height seat:
1. The seat with sliding function (the depth of the seat can be adjusted), the hollow mesh design is more comfortable to sit and maintains effective support for the thighs.
 2. Seat height adjustable by grade 4 gas lift (lifting stroke 100 mm).
 3. The wire control mechanism : back can be tilting locked in 4 different position.
 4. Tension adjustment system to adjust back tightness.
 5. 3D adjustment arm rest: front and rear adjustment, up and down adjustment, 30 degree left and right rotation adjustment, multi-angle adjustment, to meet the need of more people , and to adjustment freely.
 6. 350# grey nylon track design base (non-slip on the track), static pressure bearing 1136 kg.
 7. 60# BIFMA 360 degree running nylon castors
 8. Backrest and headrest : use NT series High elastic mesh, breathable and comfortable
 9. Seat use GB or LY series fabric (LY fabric grade 5 waterproof, grade 6 oil resistance).



Ergonesia

VASEAT WOBBLE STOOL CHAIR

+
Experience ergonomics



OUTSTANDING FEATURES

- Ventilated mesh
- Fabric seat with molded foam
- Height Adjustable
- High quality Class 3 gas lift

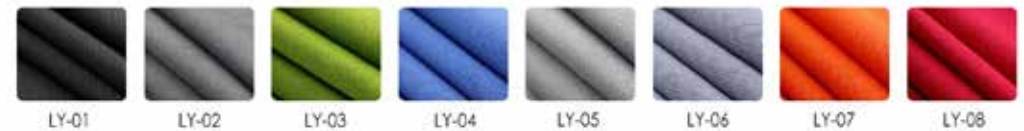

You can customize your favorite colors according to your preference and contact the business for consultation.

Spiral texture

The spiral texture is added to the base to make the chair more stable and attractive, so that the user can rotate more stably and slightly



Ergonomic office chair



Free tilt

The user can sit on the chair and tilt freely

Ergonomic office chair

Up and down

The height of the seat can be adjusted appropriately



Pull the lifting button to adjust the lifting

Ergonomic office chair

